



# X-VISION OPTICS

ROCTX LASER RANGEFINDING BINOCULAR



## RFB0842: (8X 42MM), 1950 YARD RANGE

Thank you for purchasing these X-Vision binoculars! These 2-in-1 binos combine powerful 8x magnification with a built-in rangefinder so you can keep your eyes on your target while ranging. Range finding is easy with four different modes, a maximum range of 1950 yards, and an red illuminated OLED display with adjustable brightness.

1. Eyepiece, Left & Right
2. Power / Ranging Button
3. Mode Button
4. Battery Cover
5. Laser Receiver
6. Laser Projector
7. Primary focus adjustment
8. Left- and right-eye focus adjustment

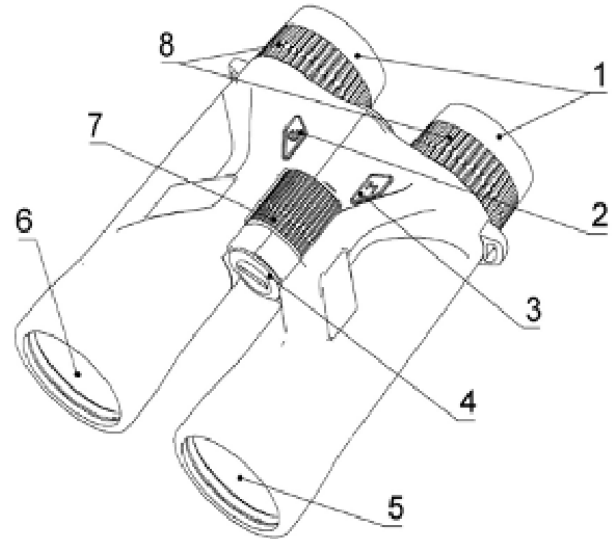

Figure 1





## EYEPIECE ADJUSTMENT



The left and right eyepieces can be independently adjusted to change the distance between your eye and the lens, depending on your personal preference. Simply twist the eyepiece counter-clockwise to extend further from the lens, clockwise to get closer.

## FOCUS ADJUSTMENT

The Focus Adjustment knob sits at the center of the binoculars. After you've set your eyepieces, look through the binoculars and turn the focus adjustment knob to bring your target into focus.

## RANGEFINDER OLED DISPLAY

1. Aiming sight 
2. Ranging Distance display - - - - -
3. Ranging Distance unit of measurement (meters or yards)
4. Ranging mode: rain , hunt , golf , standard (no display)
5. Horizontal Distance or Angle unit of measurement (meters, yards, degrees°)

6. Horizontal Distance or Angle Display - - - -
7. Horizontal Distance (HD) / Angle(∠) Indicator
8. Battery Charge Display 
9. Laser emission display 

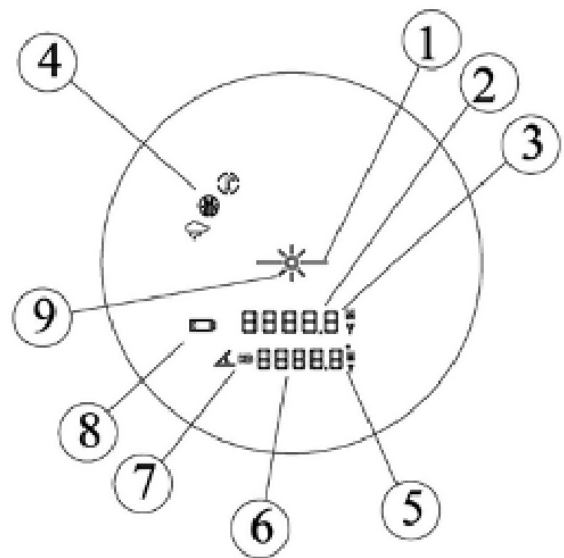









Figure 2

## BASIC RANGING OPERATION

- Rotate the eyepiece to focus the diopter
- Press the power button once to turn the unit on.
- Aim at the target with the sight 
- Press the power button with target acquired
- The laser indicator will flash on, then display the distance to the target.
- Press and hold the power button to enter scan mode, which rapidly provides distances as you move the rangefinder.
- Power will turn off automatically after 30 seconds when not in use.

## RANGING MODES

To toggle between modes, press the MODE button.

- Standard Ranging (no icon displayed) provides distance and angle measurement.
- Rain mode  is for use on rainy or foggy days where the target distance is greater than 30 yards, with horizontal distance (HD) provided.
- Golf mode  gives the priority to the nearer object, helpful in picking out a flag from objects behind it. If the rangefinder obtains multiple distances, it will display the nearest option along with a circle around the flag . If it only obtains one target, no circle will be displayed . HD provided.
- Hunt mode  gives preference to the further object, ignoring interfering objects like bushes and branches. If the rangefinder obtains multiple objects, it will display the furthest option along with the circle around the hunt icon . If one object is attained, no circle will be displayed .

## HORIZONTAL DISTANCE VS ANGLE DISPLAY

- In Standard Ranging Modes, the Angle of the target objective compared to the position of the rangefinder will be shown, in degrees, and the Angle Measurement icon  will be present in the lower-left corner of the display.
- In all other modes, Horizontal Distance is shown, indicated by the HD icon in the lower-left corner of the display. While the ranging distance will always display the point-to-point distance, accounting for elevation changes, the Horizontal Distance considers the distance without the angle accommodation.

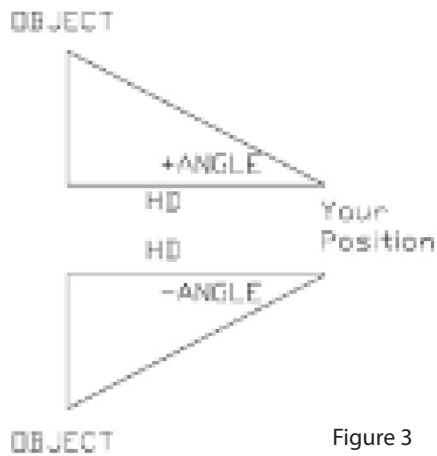



Figure 3

## ADJUSTING BRIGHTNESS

After switching between all modes, the display will show all icons and indicators at once. When in this mode, you can adjust the brightness level from 1-6 by pressing the power button  repeatedly. Press the Mode button to return to Standard Ranging mode.

## CHANGING UNIT OF MEASUREMENT

To switch between Meters (M) and Yards (Y), simply hold down the MODE button for three seconds. Y or M will show on the lower left of the display.

## FULL PERFORMANCE SPECIFICATIONS

- Maximum range: 1,950 yards / 1,800 meters
- Range accuracy: +/- 1 yard
- Angle measurement range: +/- 90° in 0.5° increments
- Angle measurement accuracy: +/- 1°
- Effective Lens Diameter: 42mm
- Eye relief: 17mm
- Exit pupil diameter: 5mm
- 8x magnification
- Power supply: CR2032 battery
- Weight: 990g
- IPX7 waterproof rating

## CAUTION

- Do not disassemble the binoculars – doing so will void the warranty
- Avoid touching the lenses with your hands--use only designated lens cleaning cloths
- Do not invert the battery
- If the binoculars will be stored indefinitely, remove the battery
- Store in a cool, dry place
- Do not use at temperatures below -4° F (-20° C) or above 104° F (40° C)